

Pracovní listy pro sestavení robota

Manipulační rameno

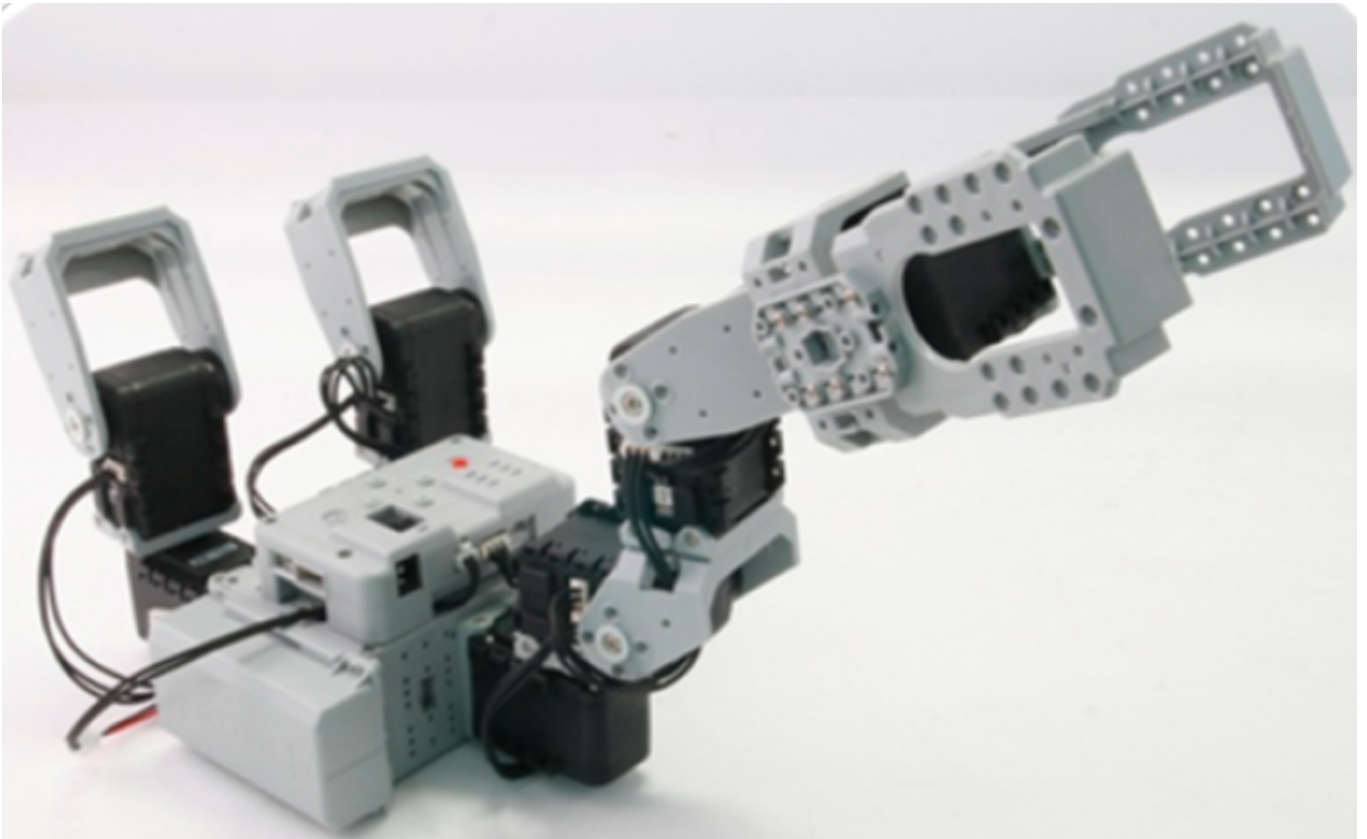

Postup sestavení robota:

Krok 1

F3 x 1

S1 x 4

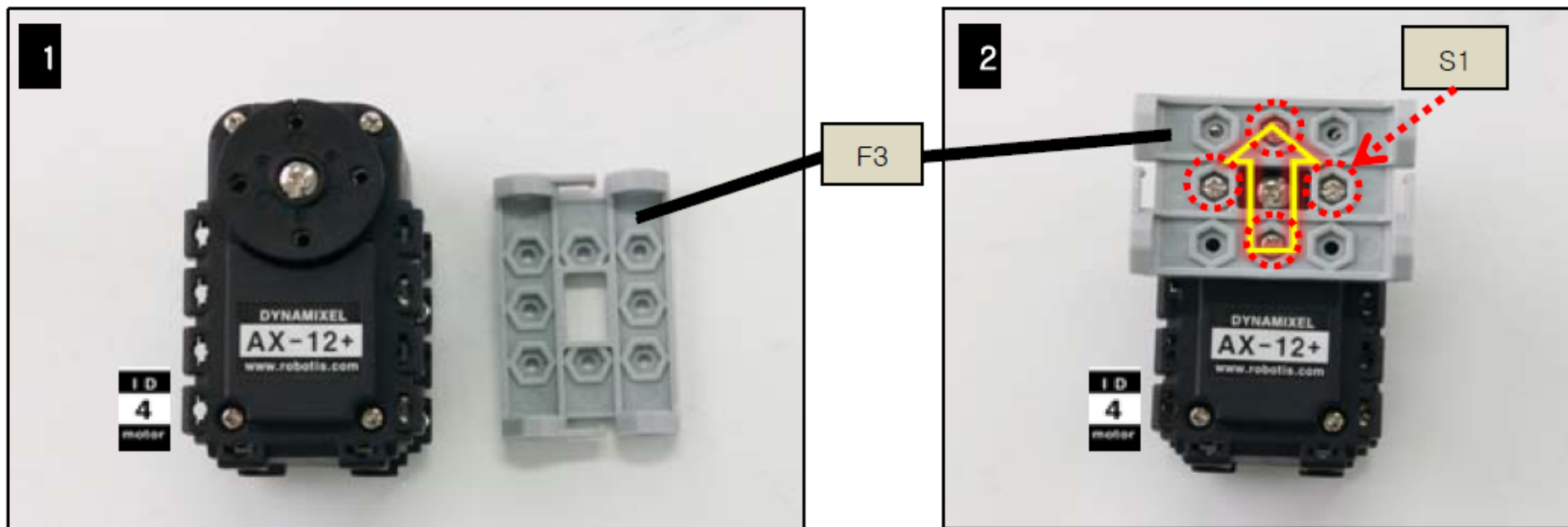

Krok 2

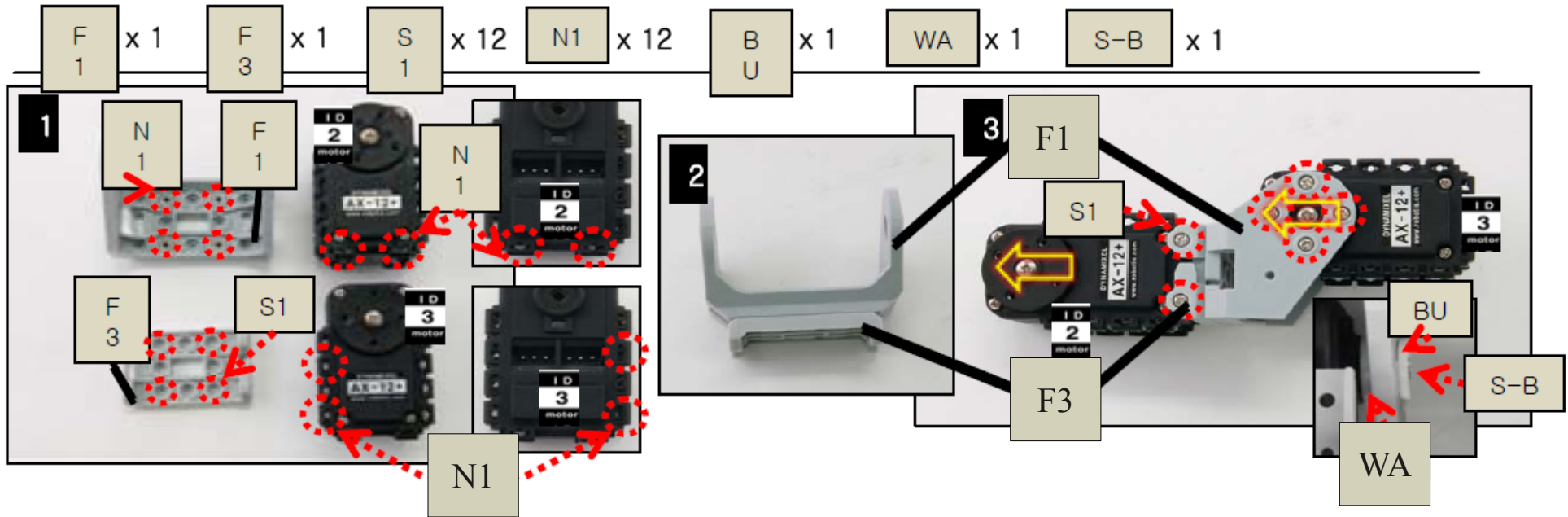

Krok 3

- F3 x 1
- F4 x 1
- F10 x 1
- S3 x 4
- N1 x 4

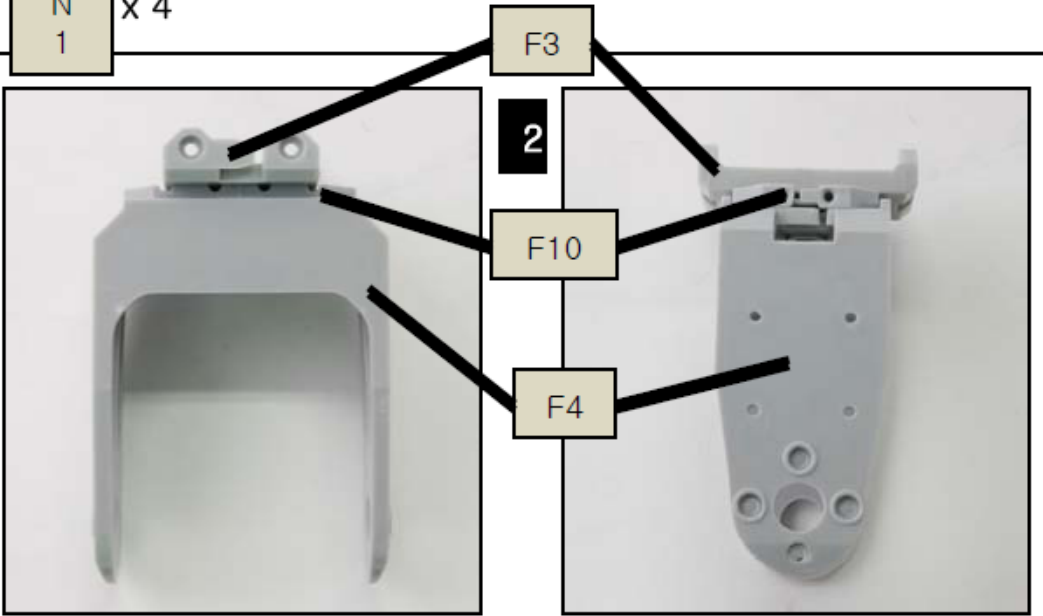
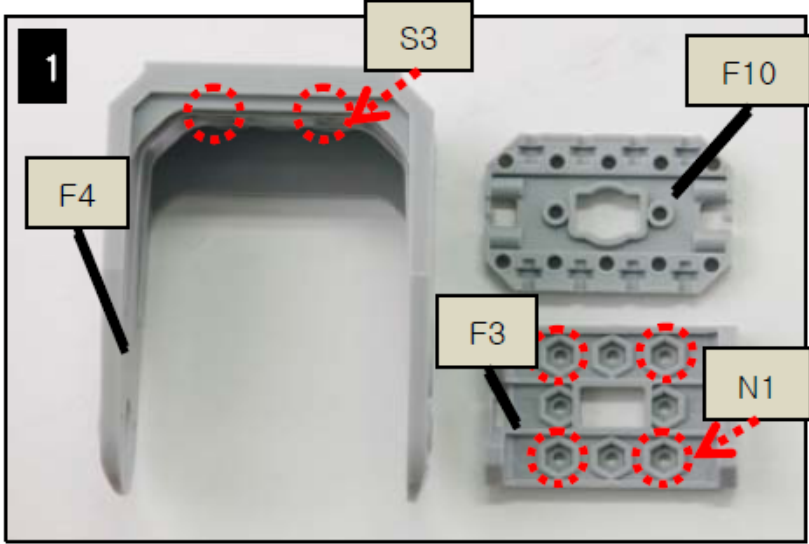

Krok 4

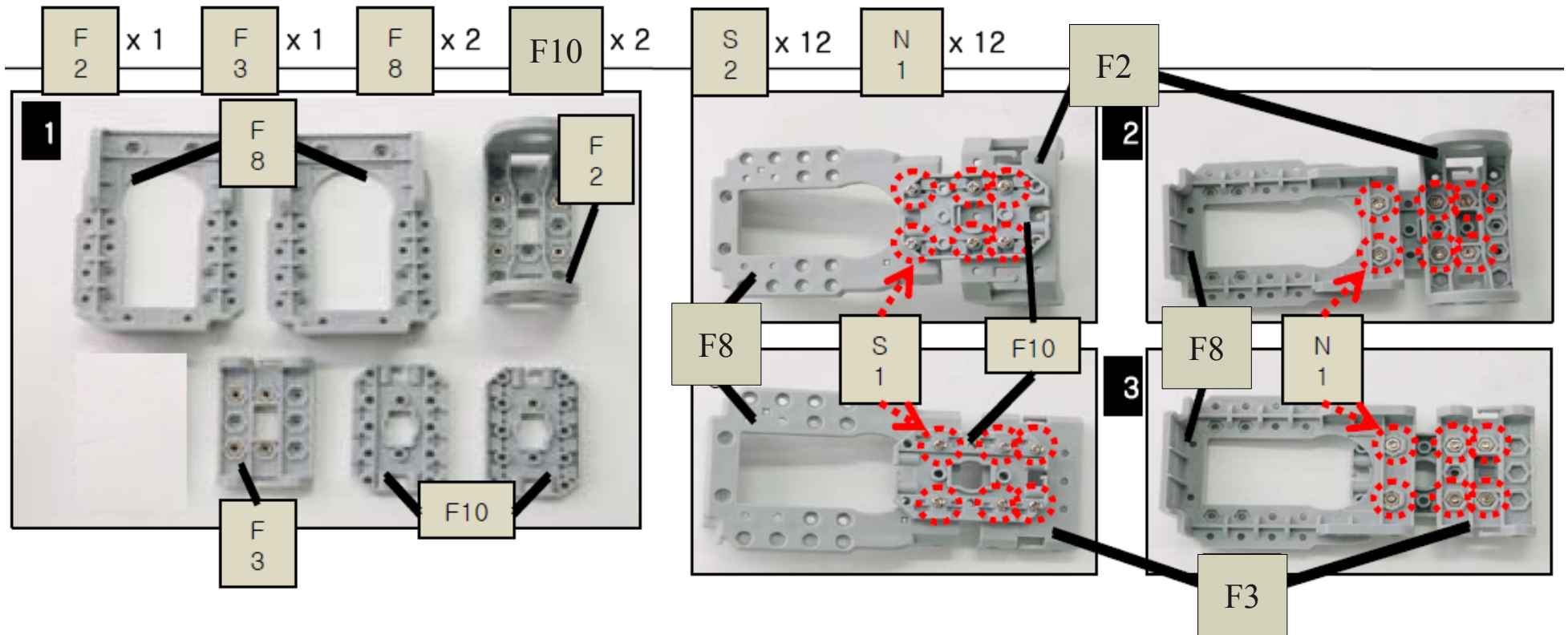

Krok 5

S1 x 8 N1 x 8 BU x 1 WA x 1 S-B x 1

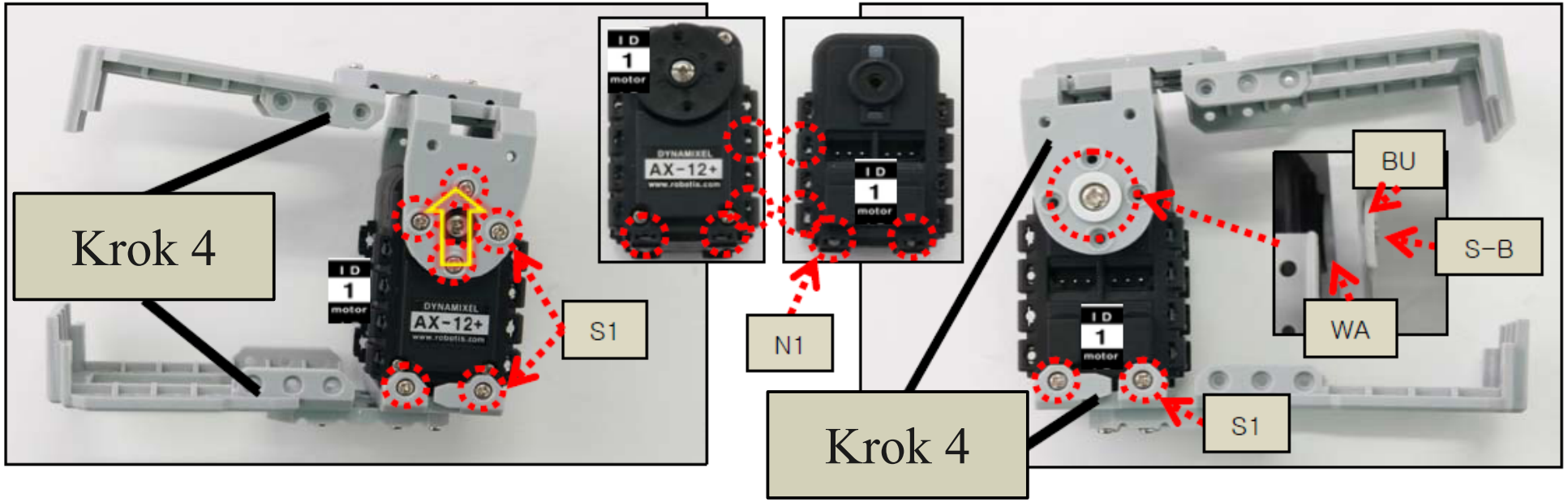

Krok 6

S1 x 4

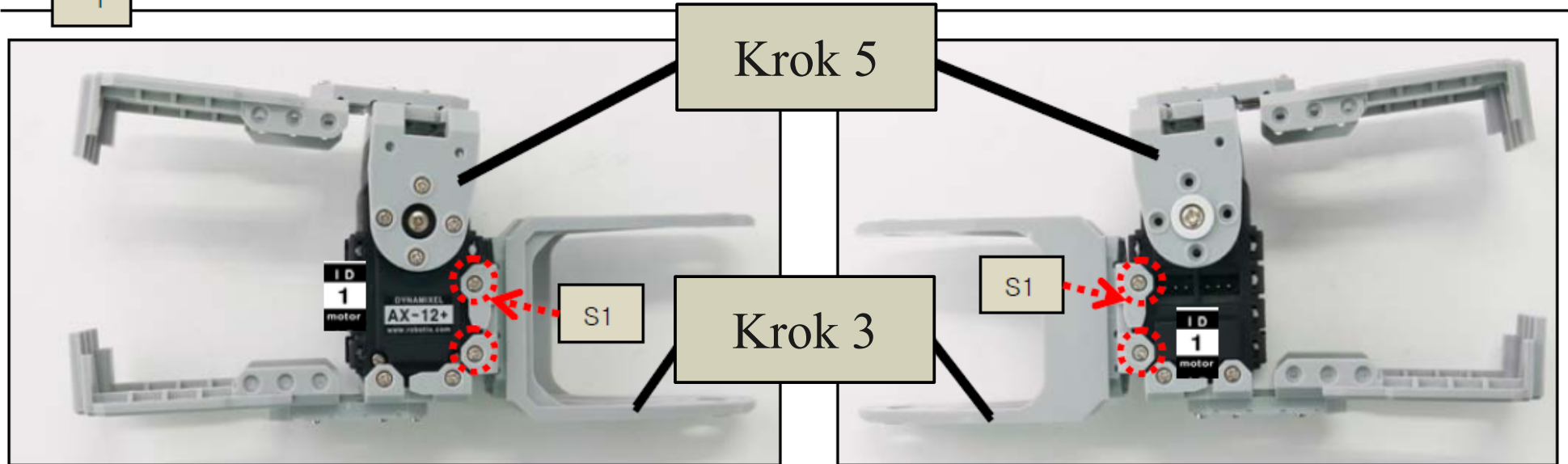

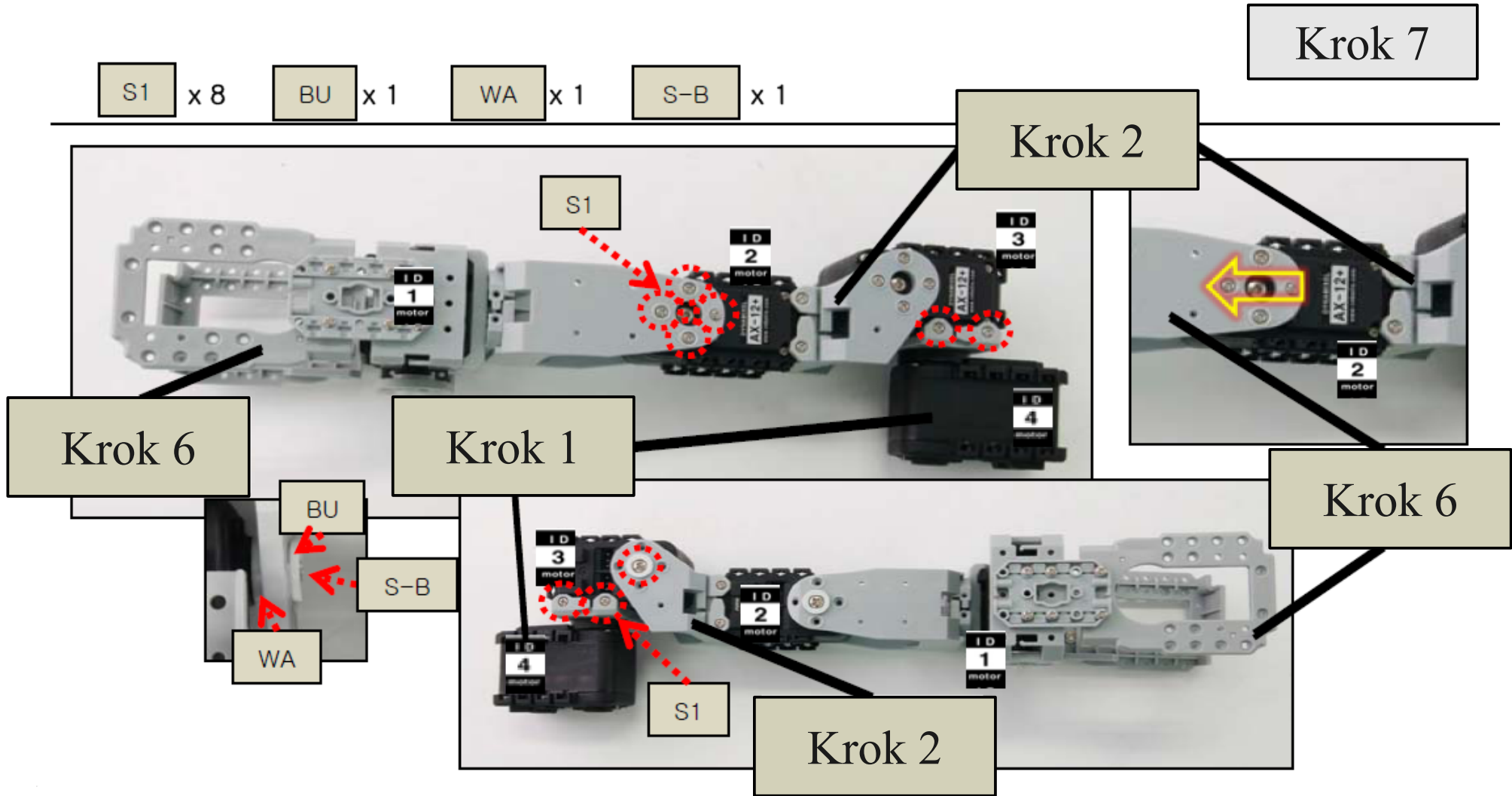

Krok 8

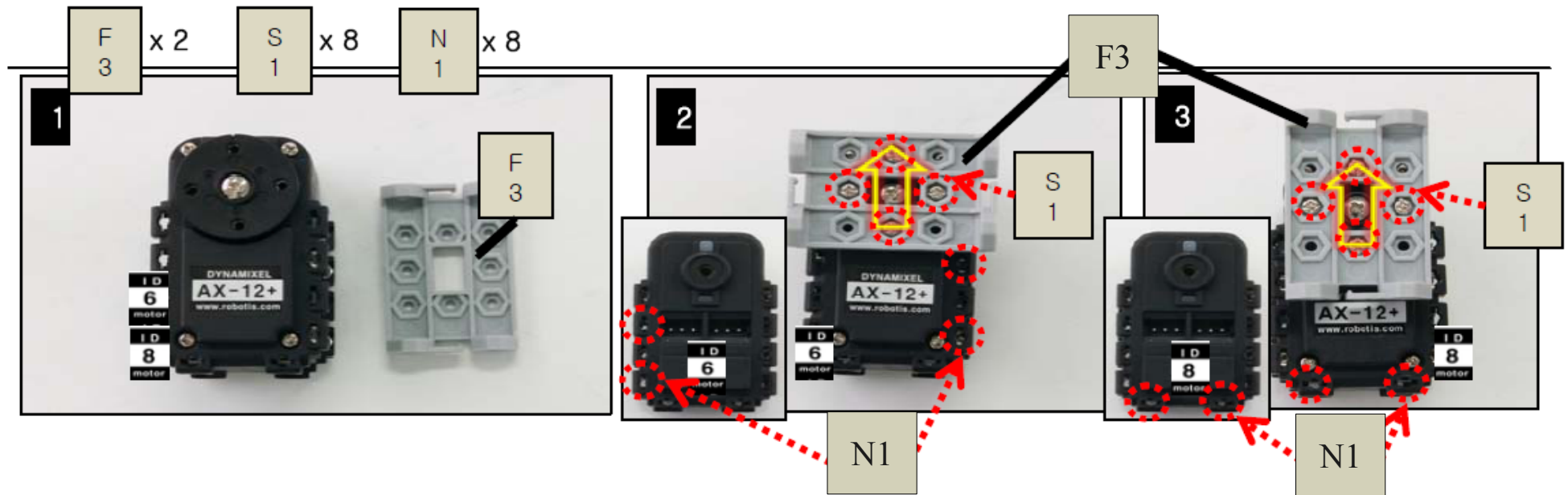

Krok 9

F4 x 2

S1 x 8

N 1 x 8

BU x 2

WA x 2

S-B x 2

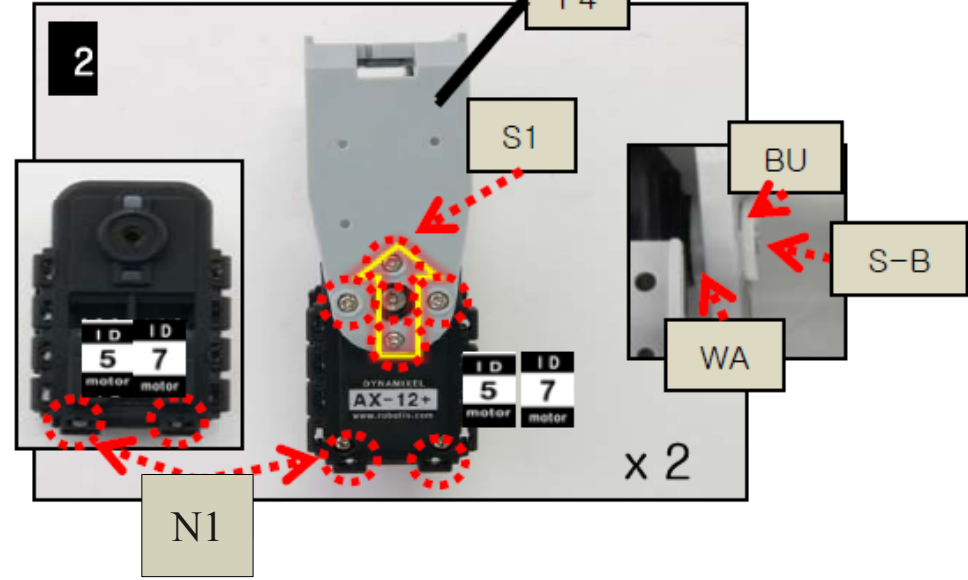
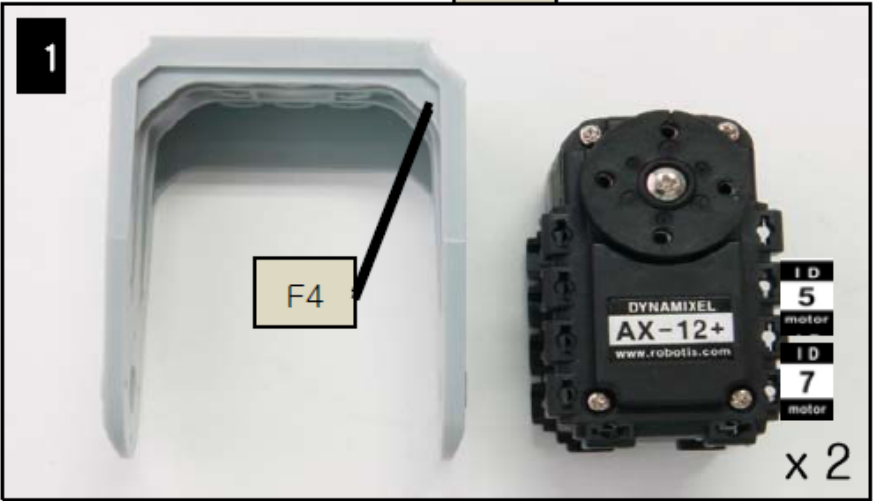

Krok 10

S1 x 8

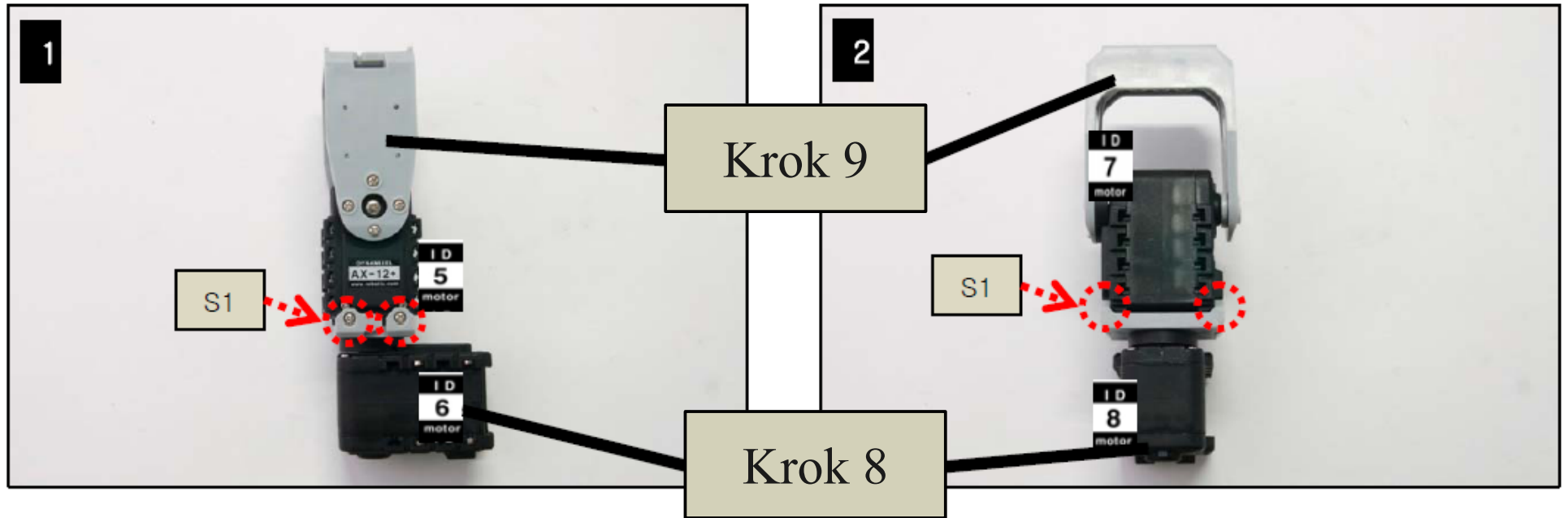

Krok 11

F3 x 2 F52 x 1 S1 x 8 N1 x 8

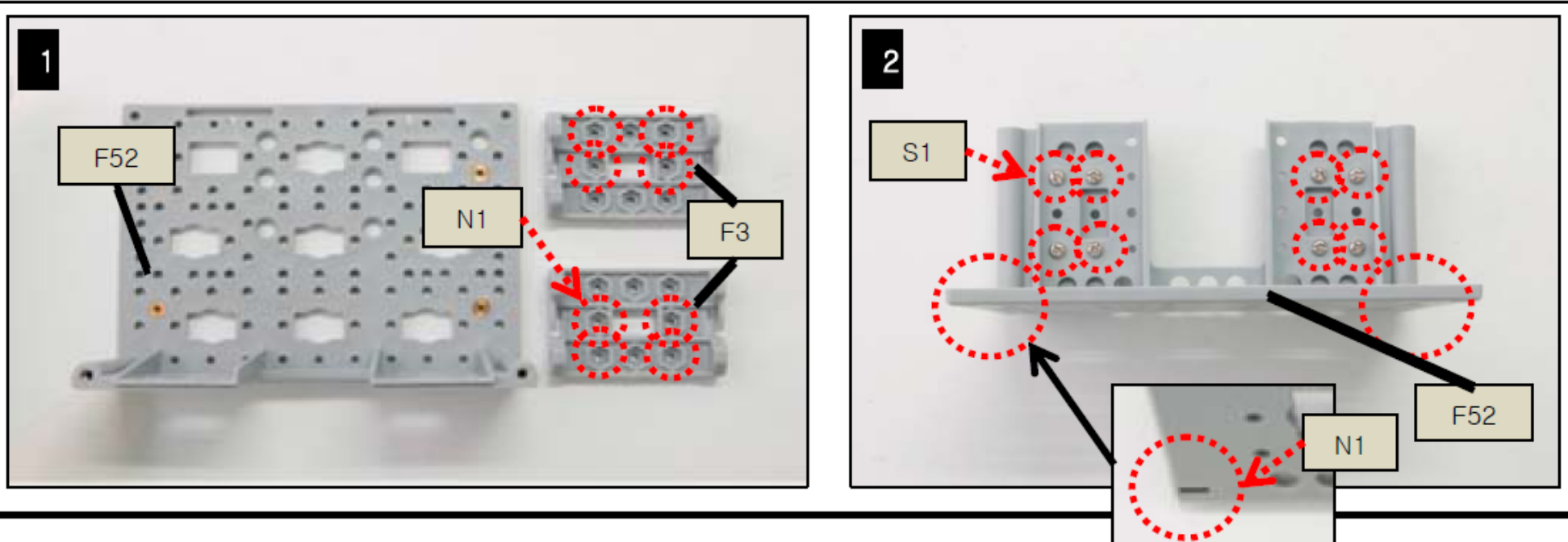

Krok 12

F3

x 1

F51

x 1

S1

x 4

N1

x 4

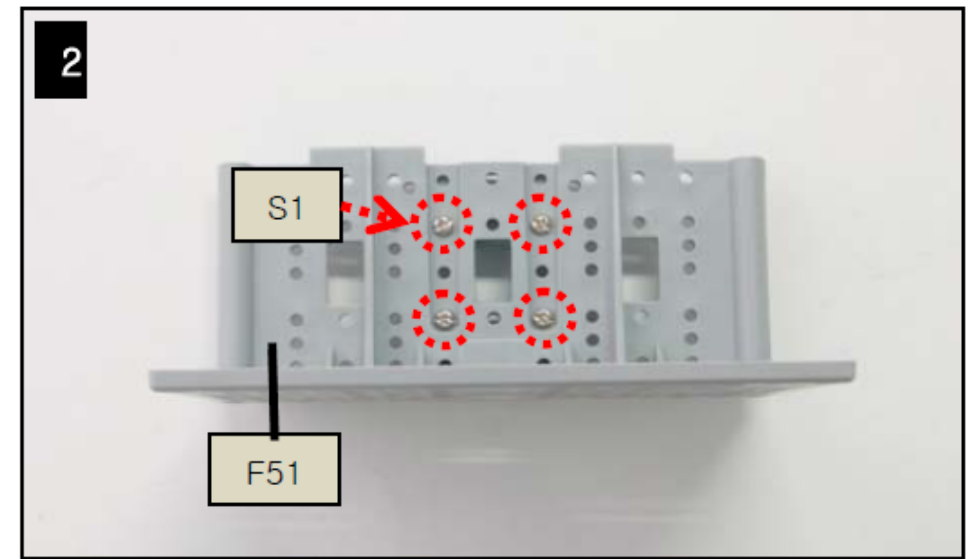
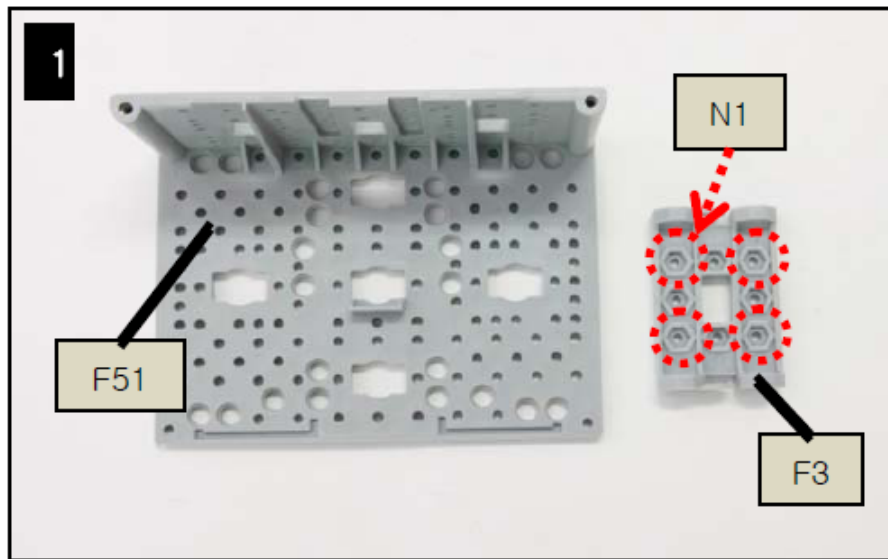

Krok 13

F3 x 1 F10 x 2 F60 x 1 S5 x 4 N1 x 4

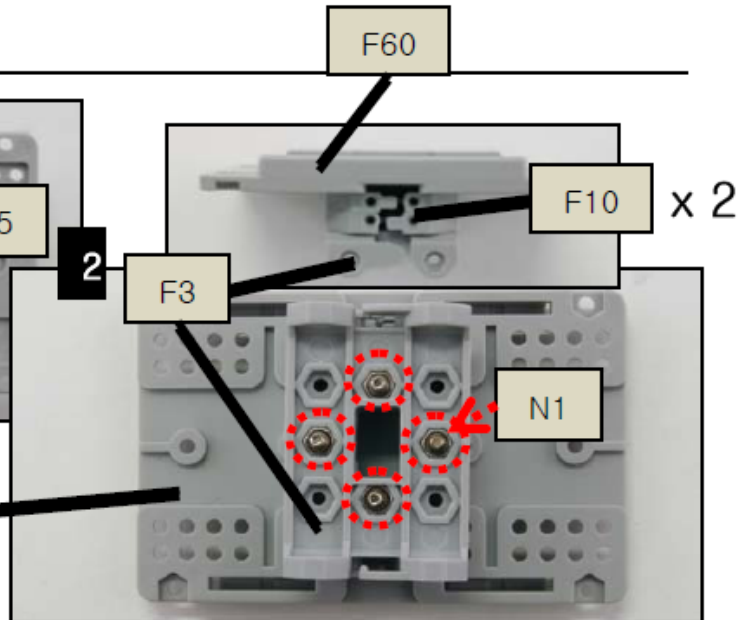
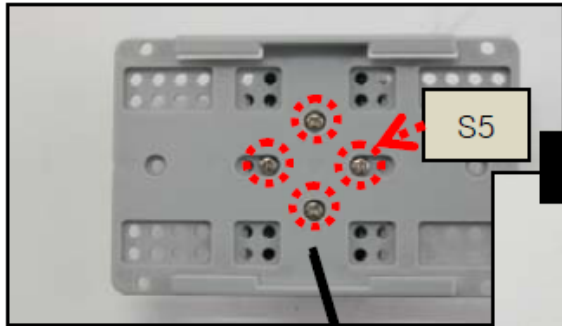
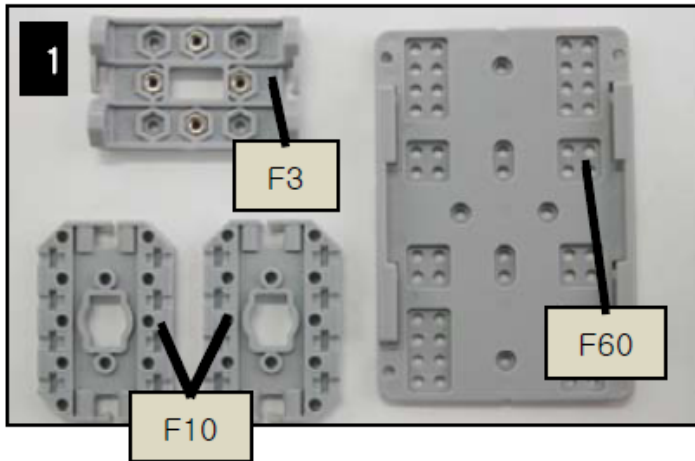

Krok 14

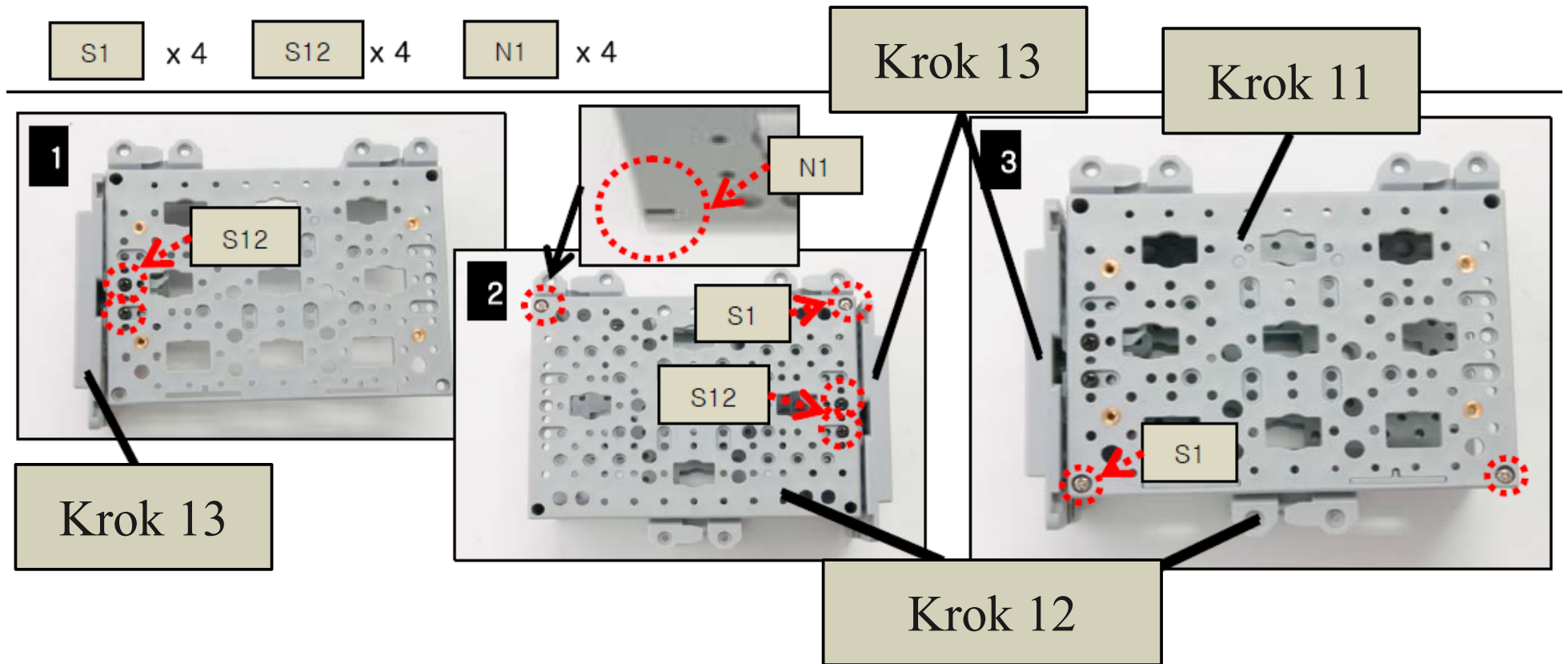

Krok 15

S1 x 16

CM-510 x 1

Krok 10

Krok 14

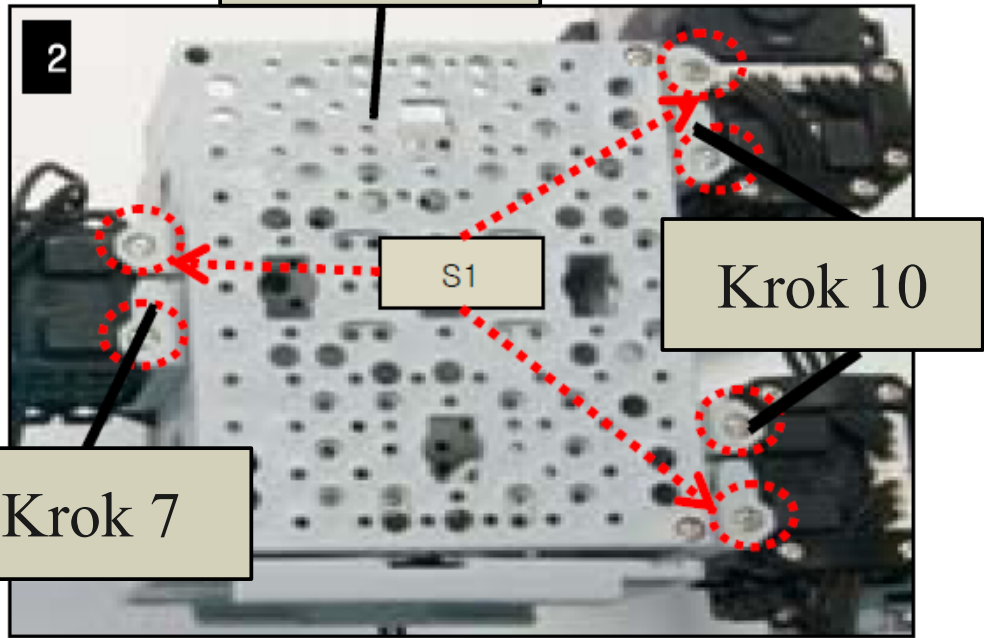
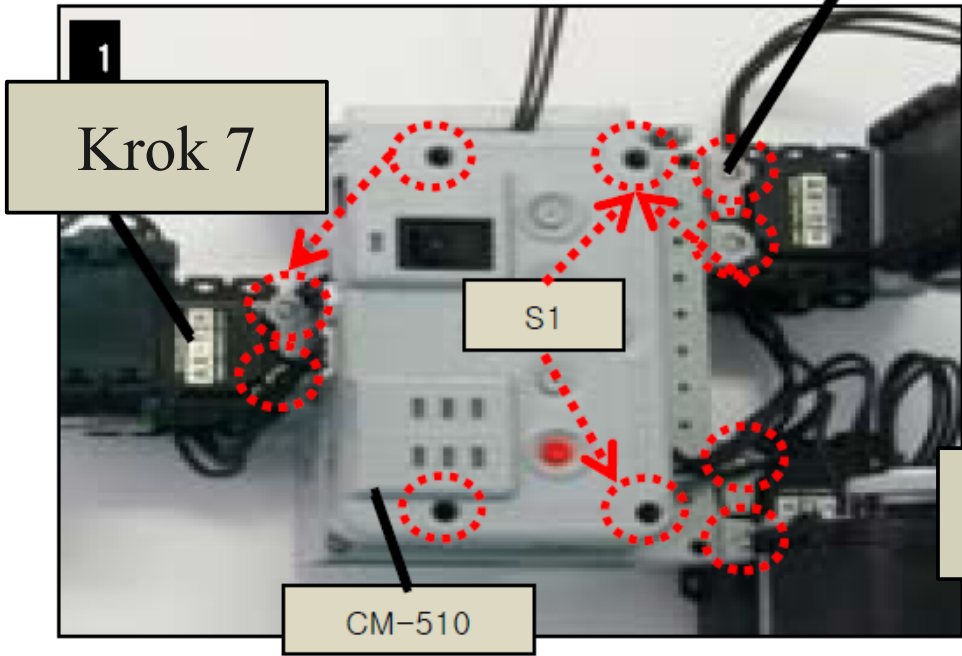

Krok 16

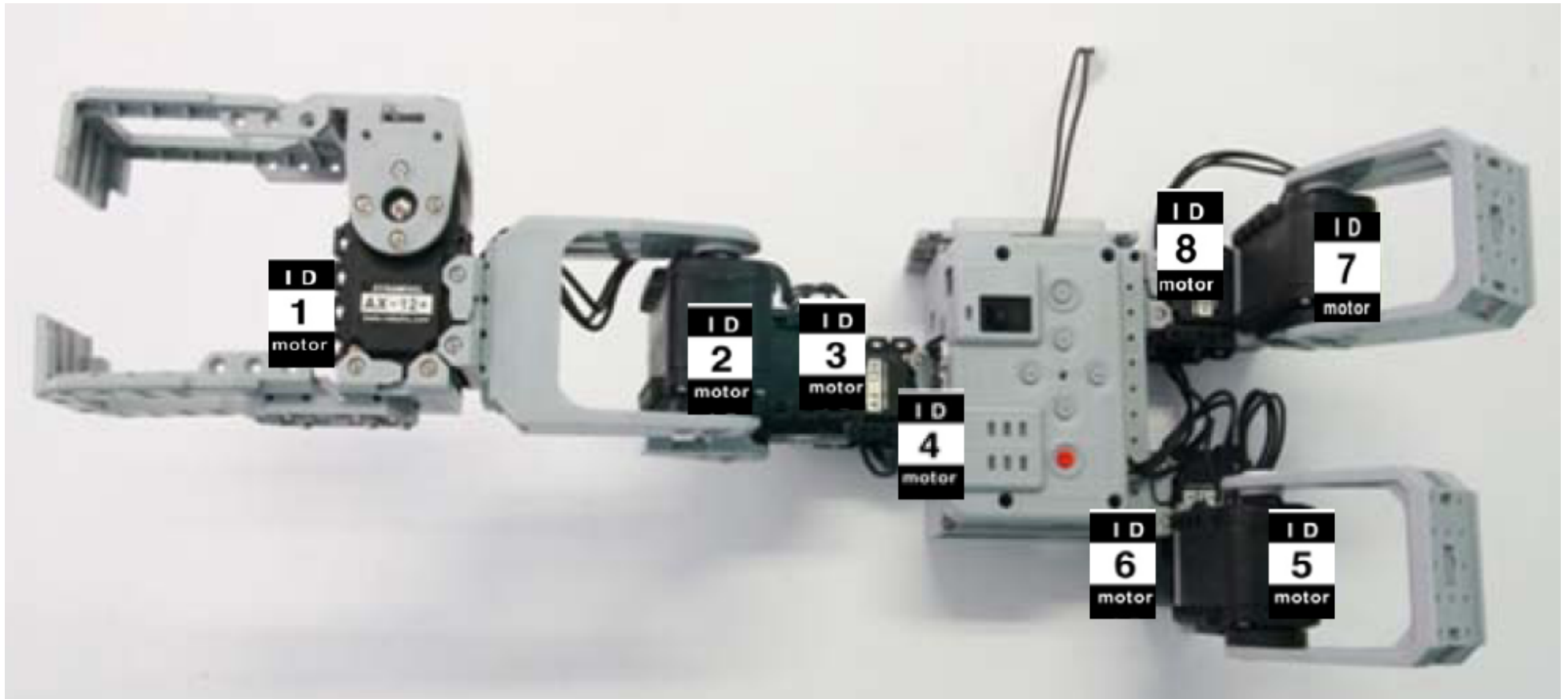

Krok 17

BATERIE

x 1

